



Ordering code

6600.Ø.stroke. _ _ .

<ul style="list-style-type: none"> 8 12 16 20 25 	<ul style="list-style-type: none"> _ _ = Without accessories A = Double regulation end stroke AU = Regulation front end stroke AR = Regulation rear end stroke D = Double shock absorber DU = Front shock absorber DR = Rear shock absorber
---	--

Construction characteristics

Body	oxidised aluminium alloy
Piston rod	stainless steel
Piston	stainless steel
Piston rod bushing	sintered bronze
End plate	aluminium
Cushioning washer	PUR
Seal	oil resistant NBR rubber
Flange	aluminium
Upper plate	aluminium

Technical characteristics

Fluid	filtered and non lubricated air
Working pressure	1.5 - 7 bar
Working temperature	-5°C - +70°C
Cushioning	with elastic bumper

Theoretical force

Bore	Effective area (mm ²)	Force (N)						
		20	30	40	51	61	71	
Ø8	Out	101	20	30	40	51	61	71
	In	75	15	23	30	38	45	53
Ø12	Out	226	45	68	90	113	136	158
	In	170	34	51	68	85	102	119
Ø16	Out	402	80	121	161	201	241	281
	In	302	60	91	121	151	181	211
Ø20	Out	628	126	188	251	314	377	440
	In	471	94	141	188	236	283	330
Ø25	Out	982	196	295	393	491	589	687
	In	756	151	227	302	378	454	529

2	3	4	5	6	7
Working pressure(bar)					

Standard strokes

Bore	Stroke					
	10	20	30	40	50	75
Ø8	●	●	●	●	●	●
Ø12	●	●	●	●	●	●
Ø16	●	●	●	●	●	●
Ø20	●	●	●	●	●	●
Ø25	●	●	●	●	●	●

Sec. A-A

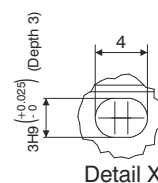
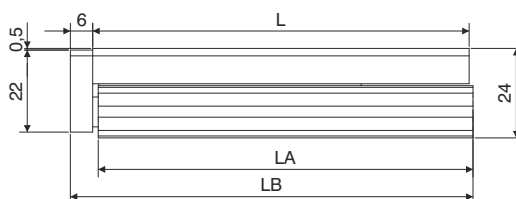
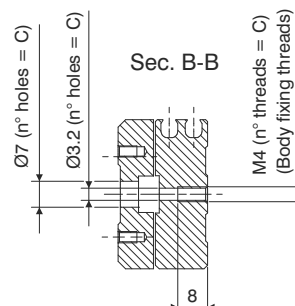
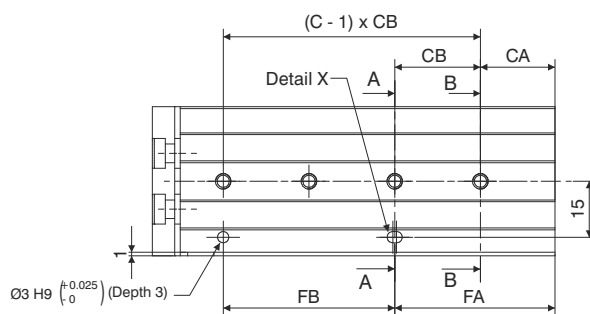
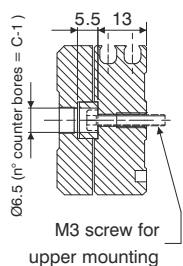

Mounting surface for stroke regulation block

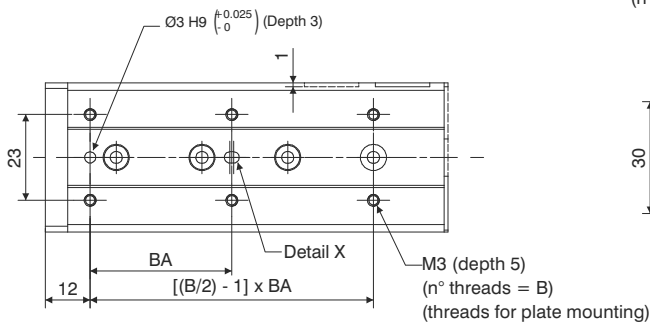
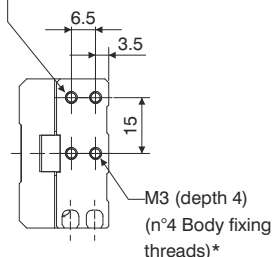

M4 (depth 6)
(n°2 Flange fixing threads)

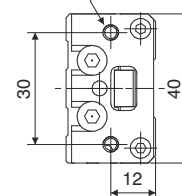

Mounting surface for stroke regulation block

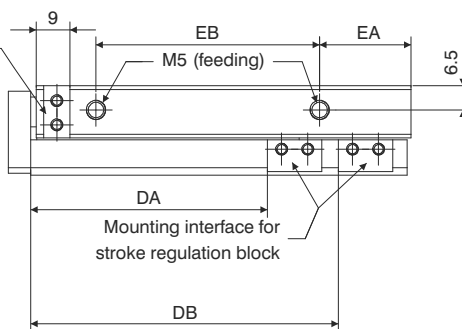

Sensor slot detail type "D"

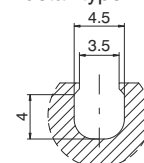

Table of dimensions

	Standard strokes					
	10	20	30	40	50	75
B	4	4	4	4	6	6
BA	25	25	40	50	38	50
C	2	2	3	3	4	5
CA	9	12	13	15	20	27
CB	28	30	20	28	23	28
DA	23.5	33.5	43.5	53.5	63.5	88.5
DB	/	/	/	/	82.5	132.5
FA	17	12	33	43	43	83
FB	20	30	20	28	46	56
EA	13	8.5	9.5	10.5	24.5	38.5
EB	19.5	29	39	56	60	96
L	49	54	65	83	101	151
LA	48.5	53.5	64.5	82.5	100.5	150.5
LB	56	61	72	90	108	158
Weight (gr.)	150	160	190	235	285	410

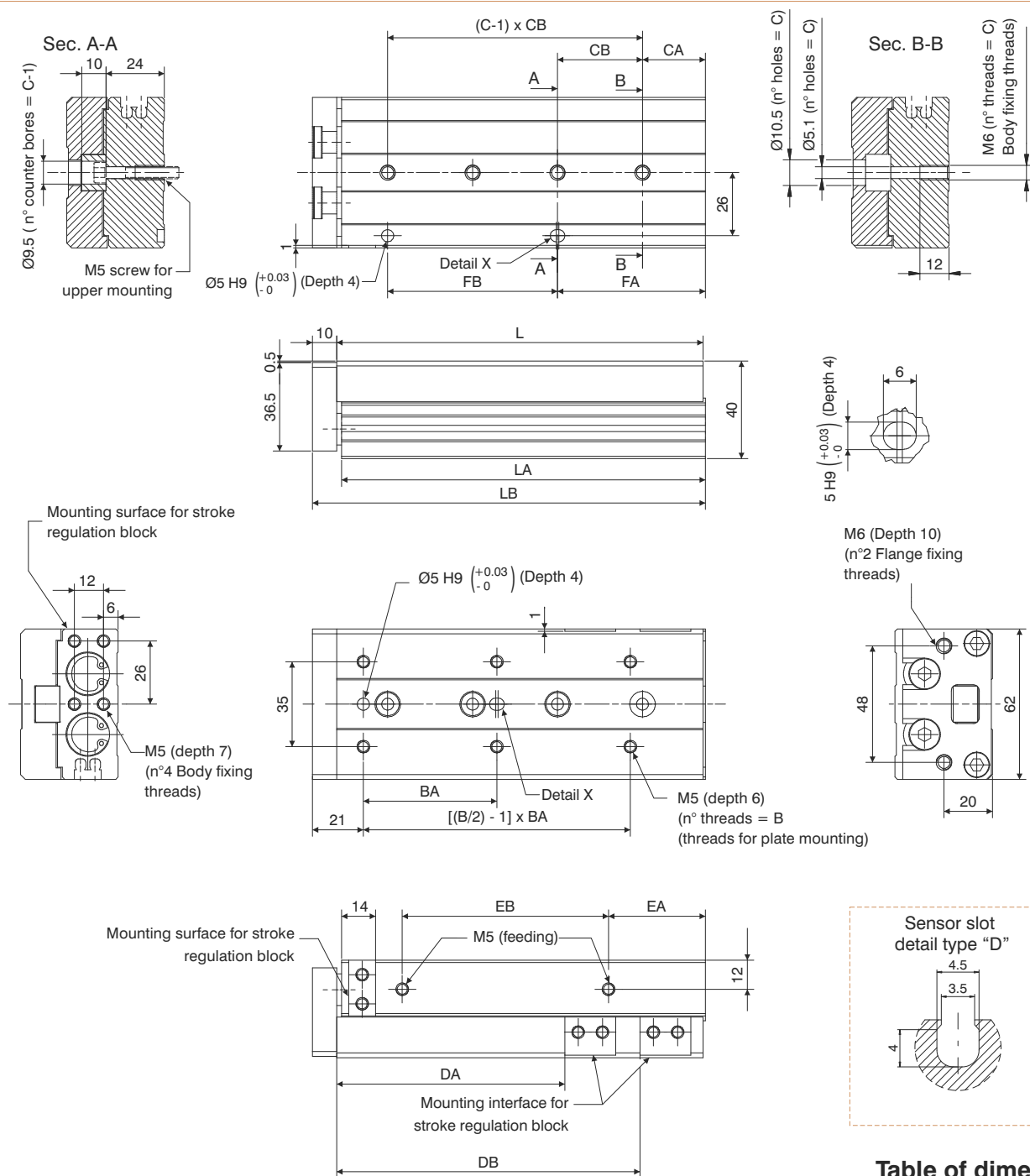

Table of dimensions

	Standard strokes								
	10	20	30	40	50	75	100	125	
B	4	4	4	4	6	6	6	8	
BA	35	35	35	40	30	55	65	70	
C	2	2	2	2	3	4	5	7	
CA	16	16	16	16	21	26	39	19	
CB	40	40	40	50	30	35	35	35	
DA	29	39	49	59	69	94	119	144	
DB	/	/	/	/	/	125	173	223	
FA	16	16	16	16	51	61	109	159	
FB	40	40	40	50	30	70	70	70	
EA	10	10	10	10	15	40	55	68	
EB	40	40	40	50	60	85	118	155	
L	76	76	76	86	101	151	199	249	
LA	75	75	75	85	100	150	198	248	
LB	87	87	87	97	112	162	210	260	
Weight (gr.)	570	570	580	640	760	1090	1370	1700	

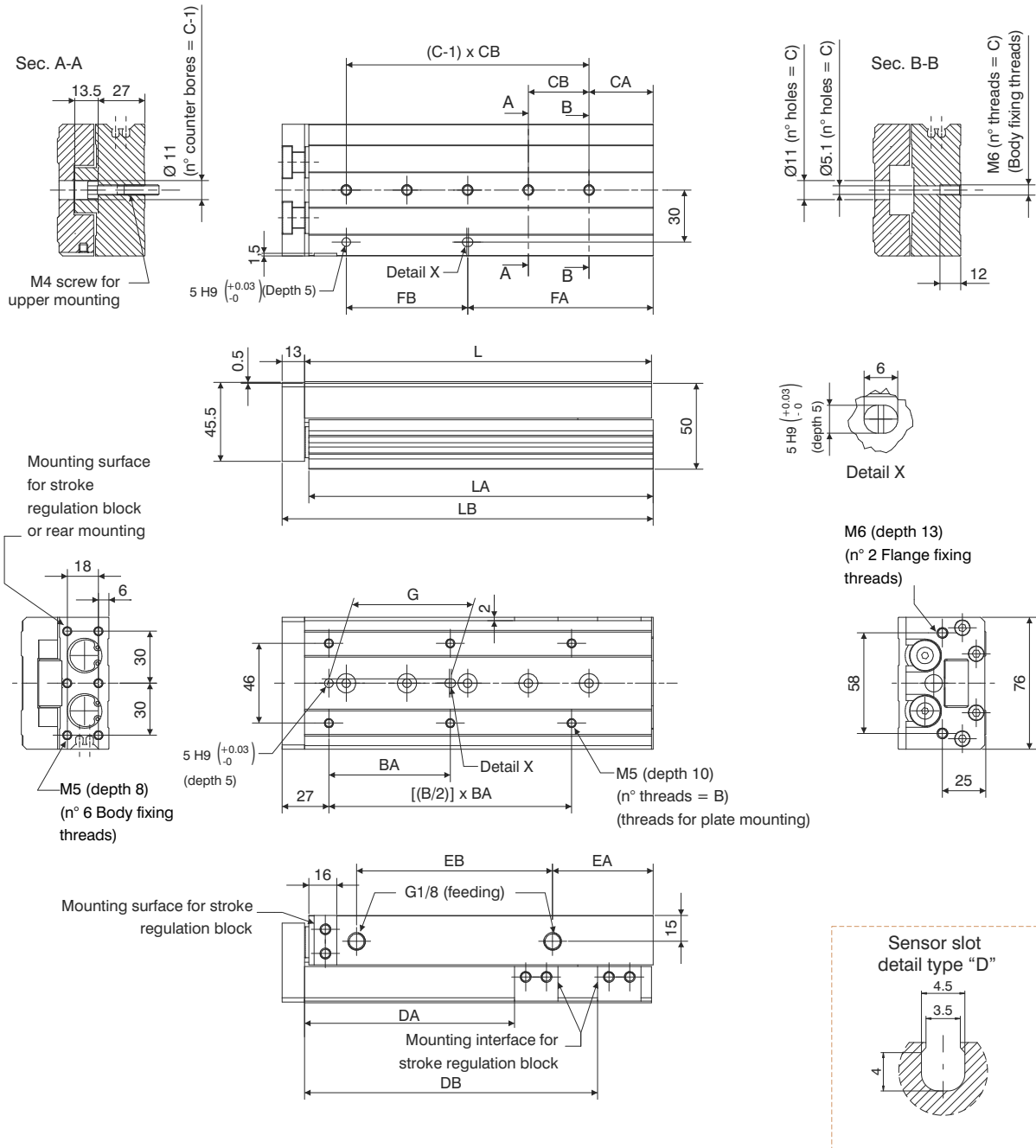

Table of dimensions

	Standard strokes								
	10	20	30	40	50	75	100	125	150
B	4	4	4	4	6	6	6	8	8
BA	50	50	50	60	35	60	70	70	80
C	2	2	2	2	3	4	5	6	7
CA	15	15	15	15	15	19	37	41	19
CB	45	45	45	55	35	35	35	38	44
DA	31	41	51	61	71	96	121	146	171
DB	/	/	/	/	/	/	169	223	275
EA	10	10	10	10	10	10	58	70	87
EB	44	44	44	54	69	108	113	155	190
FA	25	25	25	35	50	54	107	155	195
FB	35	35	35	35	35	70	70	76	88
G	40	40	40	50	35	60	70	70	80
L	83	83	83	93	108	147	200	254	306
LA	81.5	81.5	81.5	91.5	106.5	145.5	198.5	252.5	304.5
LB	97	97	97	107	122	161	214	268	320
Weight (gr.)	960	980	1010	1100	1250	1630	2150	2670	3190

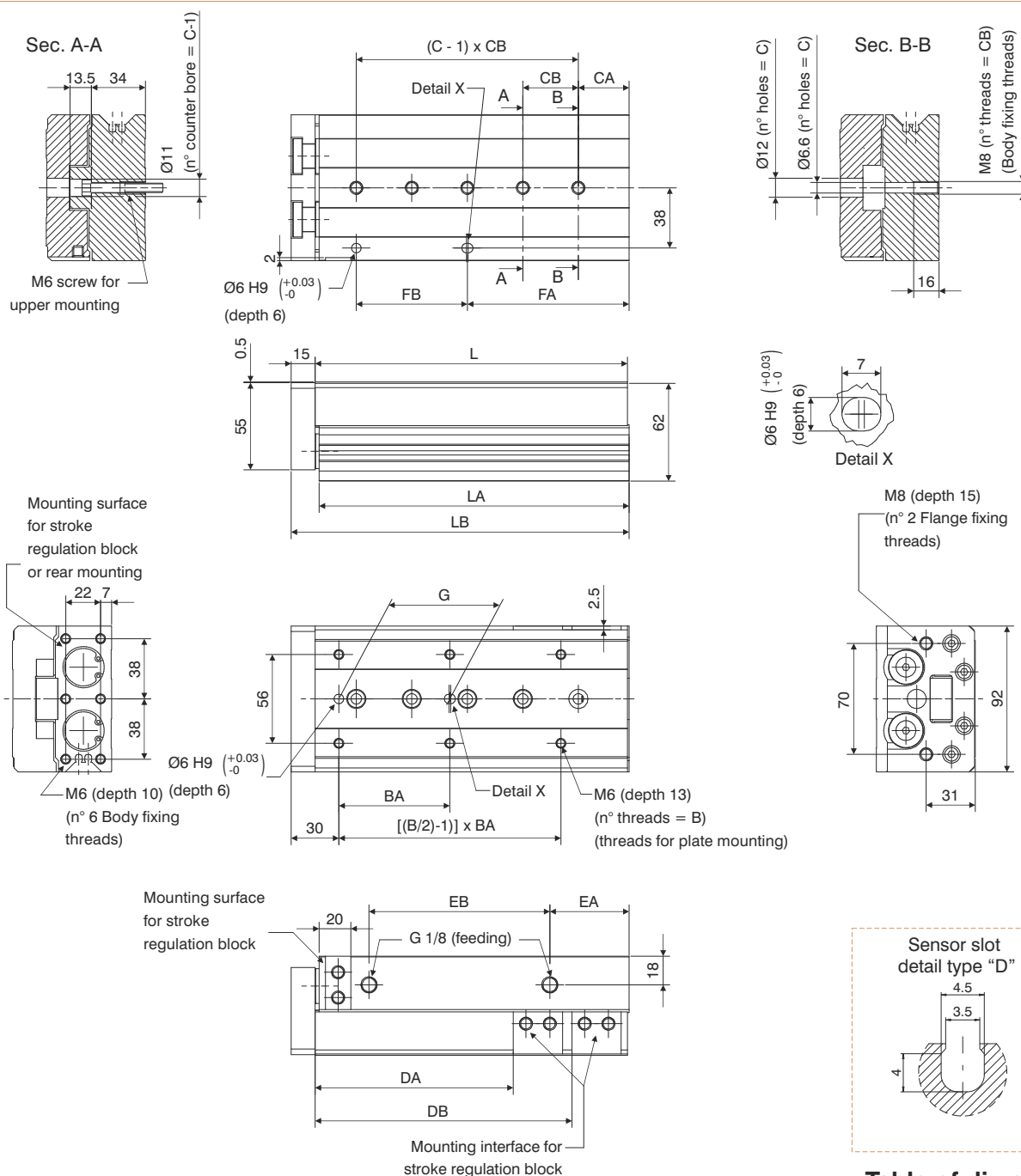
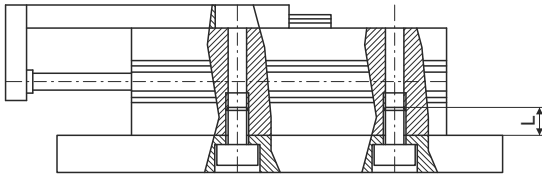

Table of dimensions

	Standard strokes									
	10	20	30	40	50	75	100	125	150	
B	4	4	4	4	6	6	6	8	8	
BA	50	50	50	60	35	60	70	75	80	
C	2	2	2	2	3	4	5	6	7	
CA	22	22	22	22	20	26	32	40	30	
CB	45	45	45	55	35	35	35	38	40	
DA	35	45	55	65	75	100	125	150	175	
DB	/	/	/	/	/	/	162	218	258	
EA	12	12	12	12	12	33	50	67	82	
EB	47	47	47	57	70	90	114	155	180	
FA	22	22	22	22	55	61	102	154	190	
FB	45	45	45	55	35	70	70	76	80	
G	40	40	40	50	35	60	70	75	80	
L	92	92	92	102	115	156	197	255	295	
LA	90.5	90.5	90.5	100.5	113.5	154.5	195.5	253.5	293.5	
LB	108	108	108	118	131	172	213	271	311	
Weight (gr.)	1660	1680	1690	1840	2090	2650	3270	4140	4710	

SIDE THREADED HOLES



Bore	Screw	Torque (Nm)	Max. Length L (mm)
Ø8	M3	2.1	8
Ø12	M4	4.4	10
Ø16	M5	7.4	12
Ø20	M5	7.4	12
Ø25	M6	18	16

SIDE THROUGH HOLES

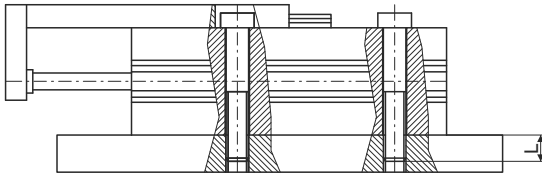

Bore	Screw	Torque (Nm)	Max. Length L (mm)
Ø8	M3	1.2	13
Ø12	M4	2.8	18.5
Ø16	M5	5.7	24
Ø20	M5	5.7	29
Ø25	M6	18	34

AXIAL THREADED HOLES

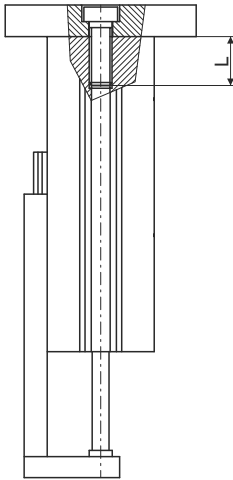

Bore	Screw	Torque (Nm)	Max. Length L (mm)
Ø8	M3	0.9	4
Ø12	M4	2.1	6
Ø16	M5	4.4	7
Ø20	M5	4.4	8
Ø25	M6	7.4	10

Mounting load

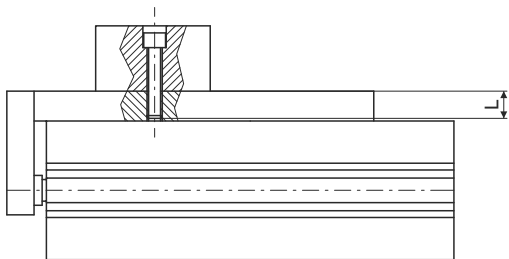

Bore	Screw	Torque (Nm)	Max. Length L (mm)
Ø8	M3	2.1	6
Ø12	M4	4.4	8
Ø16	M5	7.4	10
Ø20	M5	7.4	13
Ø25	M6	18	15

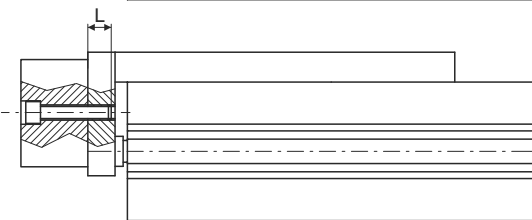

Bore	Screw	Torque (Nm)	Max. Length L (mm)
Ø8	M3	0.9	5
Ø12	M4	2.1	5.5
Ø16	M5	4.4	6
Ø20	M5	4.4	10
Ø25	M6	7.4	13

Kinetic energy (J)	Bore	With elastic bumper	With shock absorber
	Ø8	0.027	See Dampers 6900
Ø12	0.055		
Ø16	0.11		
Ø20	0.16		
Ø25	0.24		

5

With front moment under static conditions completely extended and with load applied as indicated by the arrows.

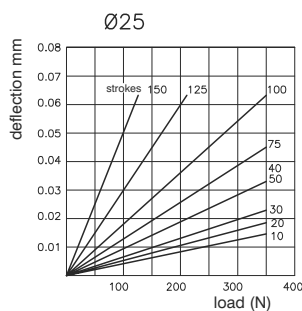
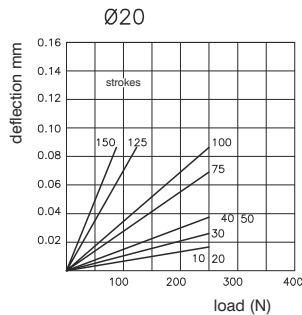
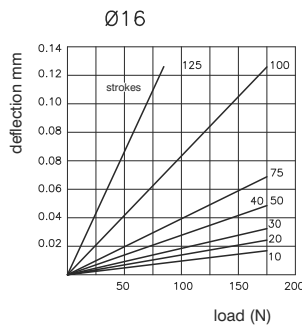
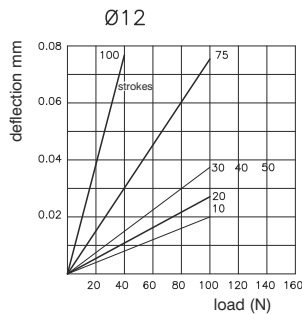
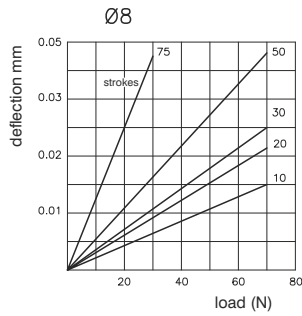
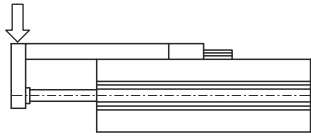

With side moment under static conditions completely extended and with load applied as indicated by the arrow

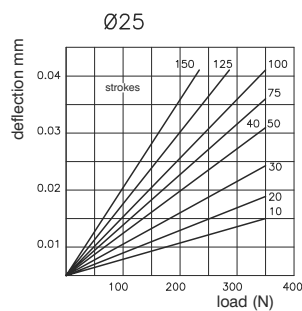
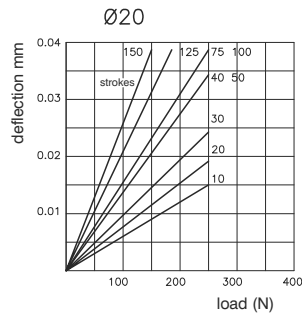
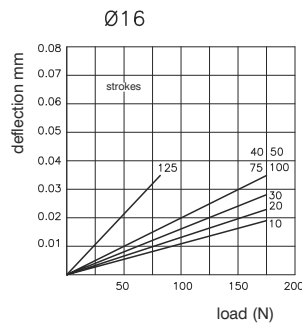
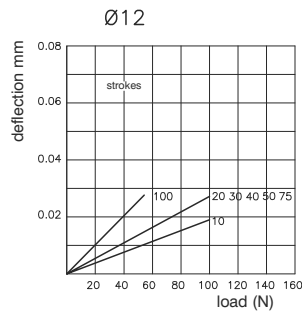
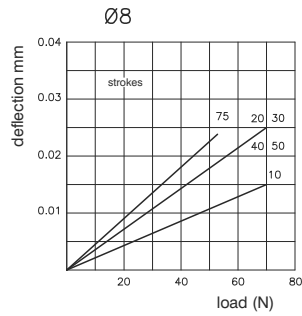
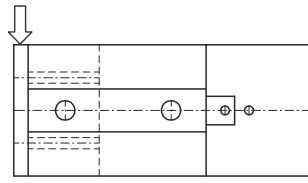

With misaligned side moment with load applied as indicated by the arrow at a distance "L" and with plate completely retracted.

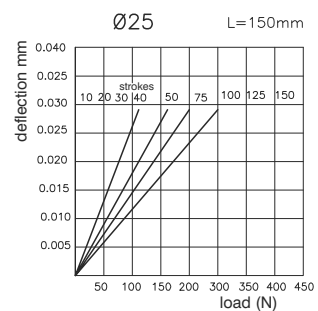
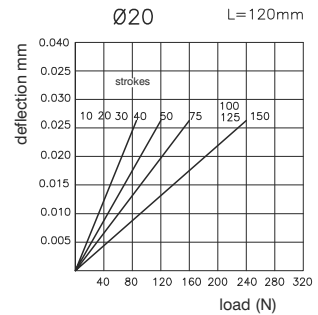
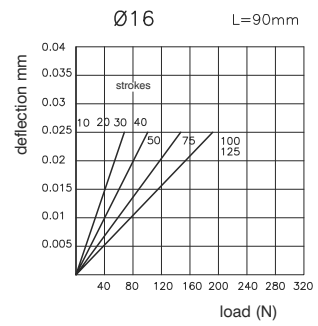
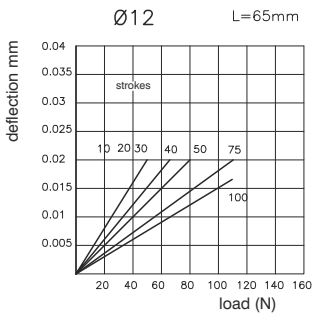
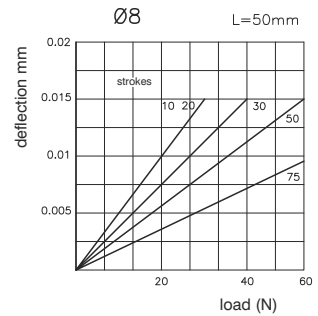
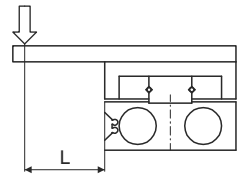

Dimensions with dampers

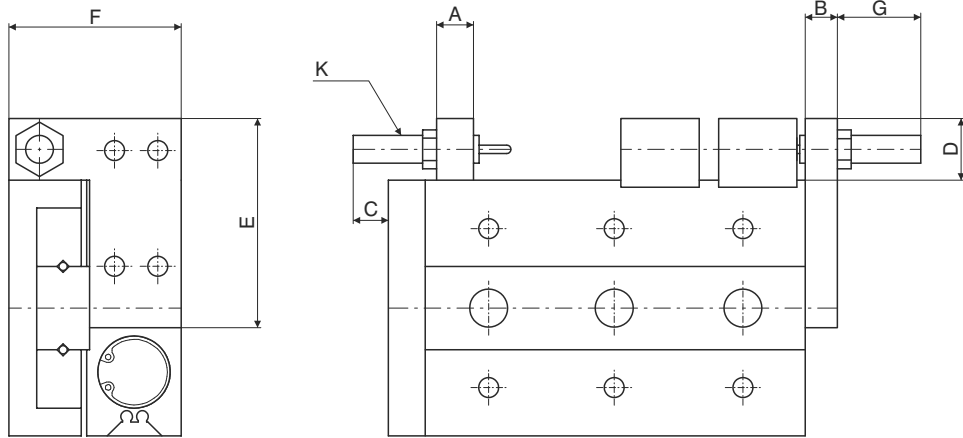

Dimensions with adjusting screw

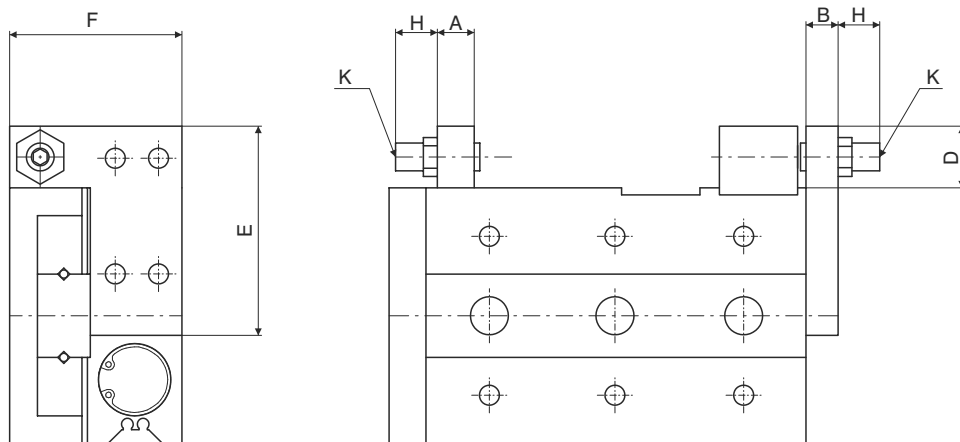

5

Bore	A	B	C	D	E	F	G max.	H max.	K
Ø8	7	8	26	14.5	38.5	23	25.5	28.5	M8x1
Ø12	9.5	8	21	15	45	31.5	24.5	32	M8x1
Ø16	11	10	19	18	55	37.5	29	34.5	M10x1
Ø20	13	12	28	24.5	70	47.5	42.5	35.5	M14x1.5
Ø25	16	15	34	24.5	80	54.5	39.5	37.5	M14x1.5

Shock absorber mounting block / front stroke adjusting screw

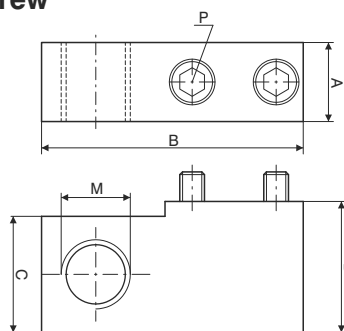

Bore	A	B	C	D	M	P
Ø8	7	23	14	15.5	M8x1	M3x16
Ø12	9.5	31	14.5	16		M4x16
Ø16	11	37	17.5	19	M10x1	M5x18
Ø20	13	45.5	23.5	26	M14x1.5	M6x25
Ø25	16	53.5		26.5		M8x25

Ordering code

6600.Ø.SU

Reference block

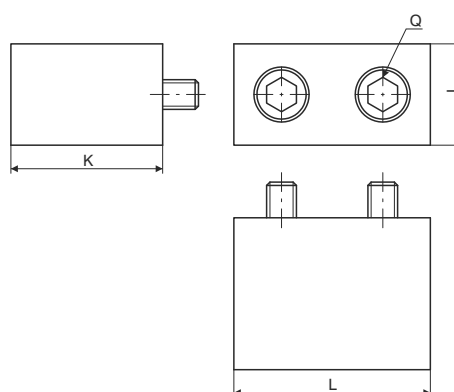

Bore	J	K	L	Q
Ø8	7	15.5	14.6	M3x16
Ø12	10	15	18.5	M4x14
Ø16	12	18.5	21	M5x18
Ø20	13	25.5	25	M6x25
Ø25	17		31	M8x25

Ordering code

6600.Ø.SI

Shock absorber mounting block / rear stroke adjusting screw

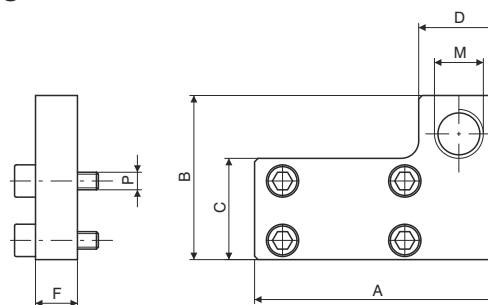

Bore	A	B	C	D	F	M	P
Ø8	38	23	12.5	14	8	M8x1	M3x12
Ø12	45	31	18				M4x12
Ø16	55	37	23.5	16	10	M10x1	M5x14
Ø20	70	47	29	23	12	M14x1.5	M5x16
Ø25	80	54	35		15		M6x20

Ordering code

6600.Ø.SR

Adjusting screw

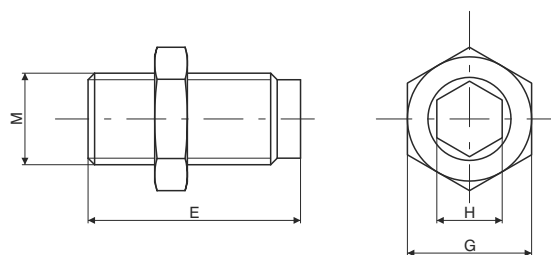

Bore	E	G	H	M
Ø8	36.5	12	4	M8x1
Ø12	40			
Ø16	44.5	14	5	M10x1
Ø20	47.5	19	6	M14x1.5
Ø25	52.5			

Ordering code

6600.Ø.VR